



TempZone™ Floor Heating Cable Installation Instructions

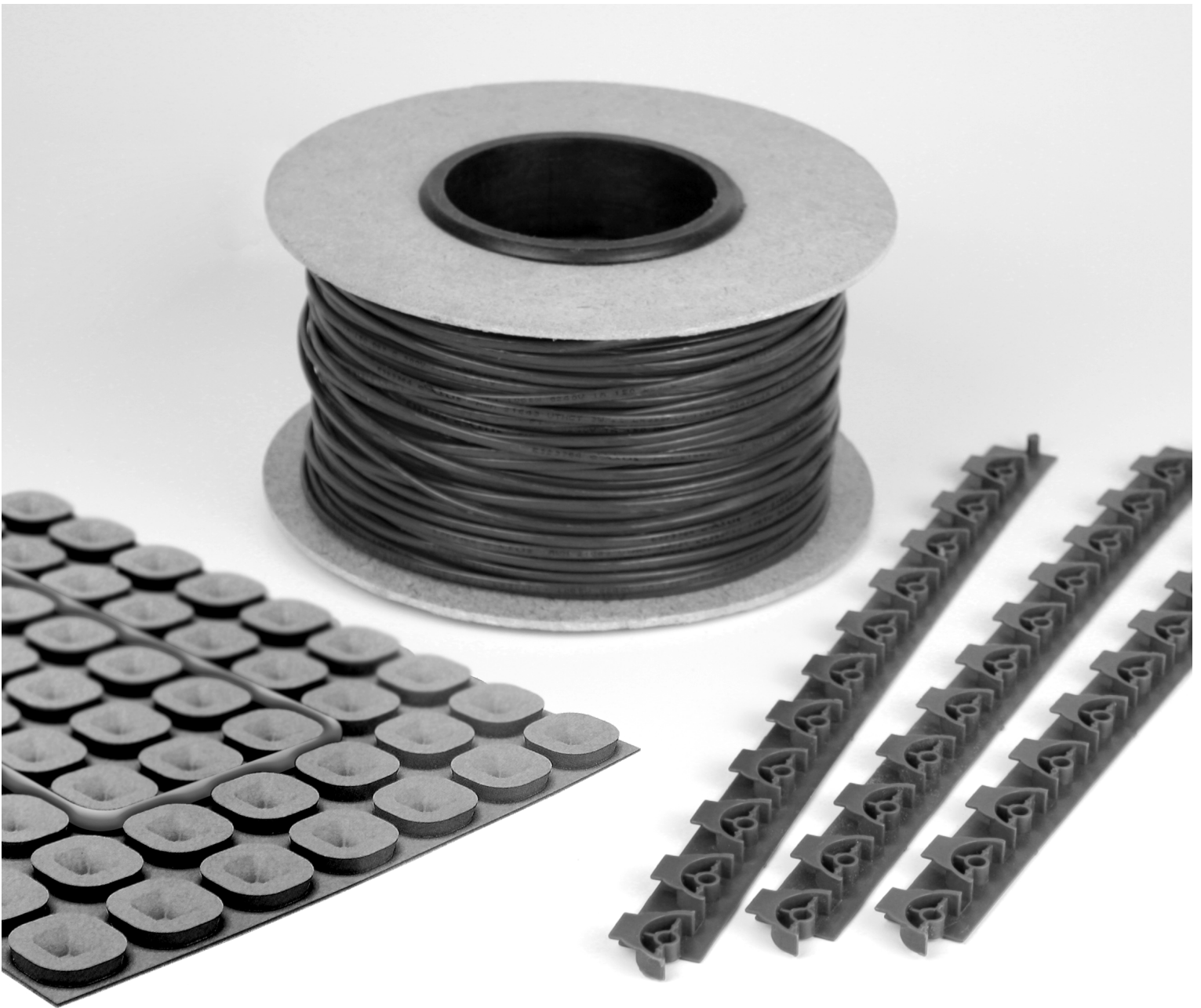

Table of Contents

1	Product Information and Specifications	1
2	Before You Begin	2
3	Planning the Installation	4
4	Electrical Considerations	6
5	Installation and Operation	9
6	Testing	16
7	Operating Tips	18
8	Troubleshooting	19
9	Addenda	23
10	Warranty Information	27

1.1 Product Specifications and Details

Radiant floor heating systems are uniquely designed for use as primary or supplemental heat sources in residential or light commercial applications for use under tile, stone, hardwood, engineered hardwood, carpet (verify installation is in compliance with local electrical code), and laminate flooring.

The TempZone™ Floor Heating Cable is composed of a twin-conductor cable and a cold lead of 15 feet for connection to a power source. The heating cable delivers 3.7 watts/linear foot. Wattage per square foot depends on the installation. Refer to the “Product Selection Guide--120V” or “Product Selection Guide--240V” in section 9 for additional information.

The TempZone™ heating cable consists of a copper alloy resistance-heating element insulated with a fluoropolymer having high dielectric strength and the ability to withstand high temperatures to ensure safety. The core is surrounded by a copper metal screening, which provides additional mechanical strength and a ground path. A foil shield surrounds the copper ground to virtually eliminate EMF. An outer fluoropolymer jacket strengthens the cable and protects against corrosion.

1.2 Selection of TempZone™ Floor Heating Cable

The TempZone™ Floor Heating Cable is available in either 120V or 240V and a range of lengths to meet the requirements of each installation. To determine the appropriate product for your installation, refer to the “Installation and Spacing Recommendations” chart below, and then consult either the “Product Selection Guide--120V” or “Product Selection Guide--240V” in section 9.

WarmlyYours TempZone™ Floor Heating Cable can be installed at 3- or 4-inch intervals to meet the needs of any installation. To determine which spacing works best for your installation, consider the following:

Installation and Spacing Recommendations

	3-inch Spacing	4-inch Spacing
Wattage (depends on cable length)	15 watts/sq. ft.	11 watts/sq. ft.
Heating Type	Primary or supplemental	Supplemental
Subfloor Type	Concrete and wood	Wood (and other non-concrete surfaces)
Flooring Type	Tile, stone, laminate, carpet *	Hardwood, engineered wood, laminate, carpet*
Wet Areas	Bathrooms, showers	N/A
Climate	Colder and warmer climates	Warmer climates
Recommended uses	Older homes where insulation may not be optimal	New homes with optimal insulation values
Coverage	120V: up to 120 sq. ft. 240V: up to 240 sq. ft.	120V: up to 160 sq. ft. 240V: up to 325 sq. ft.

**Note: Cable must be embedded in a 3/8 inch layer of self-leveling underlayment.*

2.1 General Precautions Before Installation of the TempZone™ Floor Heating Cable

- 2.1.1 TempZone™ Floor Heating Cable must NOT touch, cross over, or overlap itself at any point. This could cause the cable to overheat. Use TempZone™ Cable Fixing Strips to avoid bunching or crossover of the cable.
- 2.1.2 Do NOT cut the TempZone™ Floor Heating Cable. Altering the cable length may result in overheating and damage to the cable. Ensure that you order the correct cable length for your installation.
- 2.1.3 Take precautions to avoid damage to the TempZone™ cable during installation. Do not drop sharp objects or carelessly step on the cable. Do not bang the trowel on the heating cable while applying mortar.
- 2.1.4 If you are replacing a floor with an existing floor heating system, completely remove old mats and/or cable before installing new the TempZone™ Floor Heating Cable.
- 2.1.5 TempZone™ floor heating cables should be separated from other heat sources. Per the National Electric Code, section 424.39, heating elements of cables must be separated at least 200 mm (8 in) from the edge of outlet boxes and junction boxes that are to be used for mounting surface luminaires. A clearance of not less than 50 mm (2 in) shall be provided from recessed luminaires and their trims, ventilation openings and other such openings in room surfaces. No heating cable shall be covered by any surface-mounted equipment.
- 2.1.6 Do not install TempZone™ Floor Heating Cable when the ambient temperature is below 5°F (-15°C).
- 2.1.7 If using a thermal insulation underlayment between the self-leveling underlayment-encased cable and the final floor covering (verify installation is in compliance with local electrical code), use a product with a typical R-value of 0.027 or less.
- 2.1.8 WarmlyYours recommends using CeraZorb® underlayment when installing cable over a concrete floor or slab to allow a greater percentage of heat generated to transfer to the flooring surface.
- 2.1.9 The bending radius of the TempZone™ Floor Heating Cable during installation should not be less than 25 mm (1 in).
- 2.1.10 The cold lead is 15 feet long. WarmlyYours recommends allowing 12 inches of cold lead wire to extend from the thermostat box to facilitate easier thermostat connection. Any excess cold lead may be trimmed. Please follow all national and local electric codes.
- 2.1.11 Center the floor thermostat sensor between two adjacent runs of TempZone™ Floor Heating Cable. Do not locate floor thermostat sensor closer than 1 inch to the cable or allow it to overlap any other cable.
- 2.1.12 Carpet and laminate manufacturers may recommend a maximum limit for the temperature setting on the thermostat of 86°F (30°C).
- 2.1.13 Do not install the TempZone™ Floor Heating Cable under permanent fixtures (e.g. cabinets, bathtubs).
- 2.1.14 Allow for a sufficient drying or curing period of the subfloor and finished floor covering before and after installing the TempZone™ Floor Heating Cable. Do NOT operate floor heat until the thinset or self-leveling underlayment (SLU) has completely cured.
- 2.1.15 Please note the thickness of the factory splice and cold lead and plan accordingly. The subfloor may need to be chiseled or routed to allow placement of the splice and endcap
- 2.1.16 When using self-leveling underlayment (SLU), WarmlyYours recommends priming the floor before attaching the Cable Fixing Strips and securing the cable. Doing so will ensure that the primer covers the subfloor completely. Whenever using SLU, ALWAYS follow the installation recommendations set forth by the SLU's manufacturer. It is very important to adhere the heating cable securely to the subfloor, otherwise the heating cable may float to the top of the SLU.

2.2 Important Electrical Precautions Before Installation



IMPORTANT: Where required, all electrical connections should be performed by a licensed, certified electrician in accordance with local and national electrical code requirements.

- 2.2.1 TempZone™ Floor Heating Cable has an earth-grounding braid (metal sheath). The earth-grounding braid should be properly grounded. The core wires should be connected to the main power supply.
- 2.2.2 Verify that cable voltage matches the voltage of circuit.
- 2.2.3 Check the ohms resistance of the TempZone™ Floor Heating Cable before, during, and after installation. Resistance value should match the value given on the label attached to the cable. A tolerance of -5/+10% at 20°C (68°F) is allowed.
- 2.2.4 Local electrical codes may require the low-voltage sensor wire to be installed in conduit. If this is required, do not install the low-voltage sensor lead in the conduit containing the cold leads. Provide a separate conduit for the low-voltage sensor wire.
- 2.2.5 WarmlyYours strongly recommends connecting the Circuit Check™ device to warn of accidental damage to the TempZone™ Floor Heating Cable or lead wires during installation.
- 2.2.6 TempZone™ Floor Heating Cable should be connected to a Listed Class-A Ground Fault Circuit Interrupter (GFCI). If using one of our programmable or nonprogrammable Listed thermostats that include a built-in GFCI, then a separate Class-A GFCI is not required.
- 2.2.7 If the GFCI is tripped during normal operation and cannot be reset, there may be a fault in the cable. Do NOT attempt to re-energize the TempZone™ Floor Heating Cable. Do NOT bypass the GFCI under any circumstances. Contact a qualified electrician or WarmlyYours for assistance.
- 2.2.8 Indicate which branch circuits or circuit breakers supply the power to the floor heating cable in a convenient location (e.g. taped to the circuit breaker box) for reference by the electrical inspector or homeowner. Retain the UL labels for each TempZone™ Floor Heating Cable. Leave one UL label attached to the floor heating cable.
- 2.2.9 Use only Listed conduit, fittings, and other components.
- 2.2.10 TempZone™ Floor Heating Cable shall not extend beyond the room or area in which it originates.
- 2.2.11 The TempZone™ Floor Heating Cable should only be installed by qualified personnel who are familiar with the construction and operation of the TempZone™ Floor Heating Cable and the risks involved.
- 2.2.12 The installation of the TempZone™ Floor Heating Cable shall be in accordance with all manufacturer's instructions and local and national codes.
- 2.2.13 In Canada, the installation shall be made according to the provisions of section 62 of the Canadian Electrical Code, Part 1.
- 2.2.14 When used in wet locations, Installation shall be in accordance with the National Electric Code, NFPA-70 and CAN/CSA- C22.1, Canadian Electric code, Part 1 (CEC) and that final acceptance is to be made in the field by the Authority Having Jurisdiction (AHJ).The UL Listing for this product covers use in wet locations for US and CANADA. Wet location installation in United States shall be in accordance with the National Electric Code, NFPA 70 and any other applicable jurisdictional code and final acceptance is to be made by the Authority Having Jurisdiction (AHJ).



WARNING : Risk of electric shock and fire. Damage to supply conductor insulation may occur if conductors are routed less than 2 in. (51 mm) from this heating product. Refer to installation instructions for recommended means of routing supply conductors.

3.1 Selection of Floor Covering material

The floor covering materials used with this product must not exceed a thermal insulation R-value of 1.

Examples of Common R-values for Floor Covering Materials*

Floor Covering Material	Thickness (inches)	R-value
Carpet	3/8	1.0
Tile (ceramic, mosaic)	1/4	0.15
Laminate	3/8	0.675
Plywood	1/2	0.63
Natural stone (granite, limestone, marble, sandstone)	1	0.38 to 0.114
Wood	3/4	0.80 maximum

**These values are provided for general reference purposes only. Consult the floor covering manufacturer for product-specific information.*

3.2 Thermal Insulation

The insulation levels of the floor will affect both the performance and operating costs of the TempZone™ floor heating system. Thermal insulation reflects the heat upwards into the floor tile instead of allowing heat to penetrate into the subfloor, keeping the floor warmer for a longer time.

When the cable is installed on a concrete slab, we recommend adding a layer of insulation to the slab prior to installing the TempZone™ Floor Heating Cable. Adding insulation on top of the concrete slab and beneath any floor heating system will allow a greater percentage of heat generated to transfer to the flooring surface. WarmlyYours recommends using 5 mm thick CeraZorb® synthetic cork underlayment.

3.3 Calculation of Length of Cable Required

To determine the appropriate cable length for the installation, measure the area to be heated and calculate the area in square feet. Do not include the area covered by fixed objects, such as appliances, bathtubs, cabinets, etc. Refer to the "Installation and Spacing Recommendations" chart in section 1.2 to determine the recommended watt density per square foot for the type of installation. Refer to "Product Selection Guide--120V" or "Product Selection Guide--240V" in section 9 to select appropriate cable length.

3.4 Calculation of On-Center Spacing (OC)

In order to fit the TempZone™ Floor Heating Cable properly in the designated space, it is necessary to determine the spacing between the cables. This is called on-center spacing or OC. Refer to either the "Product Selection Guide--120V" or "Product Selection Guide--240V" in section 9 to determine appropriate spacing for the installation.

Combine cable lengths if more than one is needed for the installation. Once the OC spacing has been calculated and the correct length of cable for the area to be heated is obtained, installation of the floor heating cable can begin. The formula assumes that 3-inch spacing will be used between the heating cable and walls or fixed objects, and full OC spacing between cable runs. To make cable placement easier, make a measuring template out of cardboard in the width of the OC spacing less the thickness of the cable. Place the template along to the cable run just completed to determine where the next run of cable should be positioned.



IMPORTANT: To avoid overheating, OC spacing should not be less than 3 inches and area loading should not exceed 15 watts/square foot.



IMPORTANT: Do not order more cable than necessary as cable cannot be shortened.

3.7W Cable vs 3W Cable Wattage Yields

	3 W Cable	3.7 W Cable	Membrane Type (number of studs)
Watts/linear ft	3	3.7	
Watts/ft ² at 2.5"	14.4	17.76*	Prodeso (2)
Watts/ft ² at 3"	12	14.8	Cable Fixing Strip (3)
Watts/ft ² at 3.5"	10.3	12.7	DITRA-HEAT (2)
Watts/ft ² at 3.75"	9.6	11.84	Prodeso (3)
Watts/ft ² at 4"	8.7	11.1	Cable Fixing Strip (4)
Watts/ft ² at 4.75"	7.6	9.3	DITRA-HEAT (3)
Watts/ft ² at 5"	7.2	8.9	Cable Fixing Strip (5) & Prodeso (4)
Wire diameter	variable	4.37	

DITRA-HEAT: 1.75"

Prodeso spacing: 1.25"

Strips: 1"

*Not recommended as it exceeds the 15 watt per square foot limit set by the National Electric Code.

4.1 Floor Sensors and Temperature Control

Floor Sensor (not required for all systems)

Systems using a nSpiration Series control may require a low-voltage floor sensor. Carpet or laminate flooring manufacturers may require the use of a low-voltage sensor with their floor covering. Check with the manufacturer for specific recommendations.

This sensor is embedded in the floor and monitors the floor temperature. Check the ohms reading of the sensor wire before and after installation to make sure it has not changed. Most sensor wires have an ohms reading of 8,000 to 20,000 Ω , and your ohmmeter must have a 20 k Ω setting for this measurement. The floor sensor should be centered in between two resistance wires, leaving approximately 1.5 inches on either side and extending about 6 inches into the heated area. Avoid placing the sensor in an area affected by a draft, a radiator or other heat source, or the sun. A second, backup sensor may be installed and can be purchased separately.

The sensor cable should be routed to the thermostat and installed on the wall at a suitable operating height.

Do not allow any other cable to overlap the sensor cable. When heating laminate and carpeted floors (U.S. only), the maximum temperature setting limit on thermostat should not exceed the flooring manufacturer's recommendations.

Route TempZone™ Floor Heating Cable lead wires to a junction box or to the thermostat. Never connect the floor heating cable to other cables. The thermostat and the cable lead wires must be connected in parallel--not in series.

Type of Wire	Color
120 V	Yellow and Black
240 V	Red and Black
Floor Sensor	Black

4.2 Electrical Requirements for the System

Where required, all electrical work for the floor heating cable installation must be done by a qualified, licensed electrician in accordance with local building and electrical codes and the National Electrical Code (NEC), especially Article 424, Part IX of the NEC, ANSI/NFPA 70 and Section 62 of the Canadian Electrical Code (CEC), Part I, as well as any other applicable statutory requirements.

WarmlyYours recommends the following controls and accessories for the TempZone™ Floor Heating Cable:

- nSpiration Series controls feature a Listed Class-A GFCI and a floor sensor to regulate the actual temperature of the floor
- Non-GFCI circuit breaker

In most installations, a Class-A GFCI is required by national and local codes for protection against ground leakage currents. A Class-A GFCI is included with the nSpiration Series controls. If not using a WarmlyYours thermostat, a Class-A GFCI thermostat or circuit breaker may be needed.

The TempZone™ Floor Heating Cable should be connected to a non-GFCI circuit breaker for complete disconnection on all poles with minimum 0.12 inch disconnection distance.

The thermostat should be installed in a single-gang box, flush with the wall at a height of approximately 5 feet or eye level for easy access and operation. The floor sensor cable and the TempZone™ Floor Heating Cable cold leads shall be routed to the thermostat in separate UL Listed conduits if conduit is required by local and national electric codes.

If the floor heating cable load exceeds the 15-amp thermostat power rating, consult WarmlyYours for information on alternative solutions using master thermostats and power modules.

4.3 Wiring Diagram

Note: All electrical work must be done by a qualified, licensed electrician in accordance with local building and electrical codes, and the National Electrical Code (NEC), especially Article 424, Part IX of the NEC, ANSI/NFPA 70 and Section 62 of the Canadian Electrical Code (CEC), Part I, as well as any other applicable statutory requirements.

Example of typical wiring diagram for 120V or 240V installations is given in Figure 1. Refer to the instructions that came with your specific thermostat.

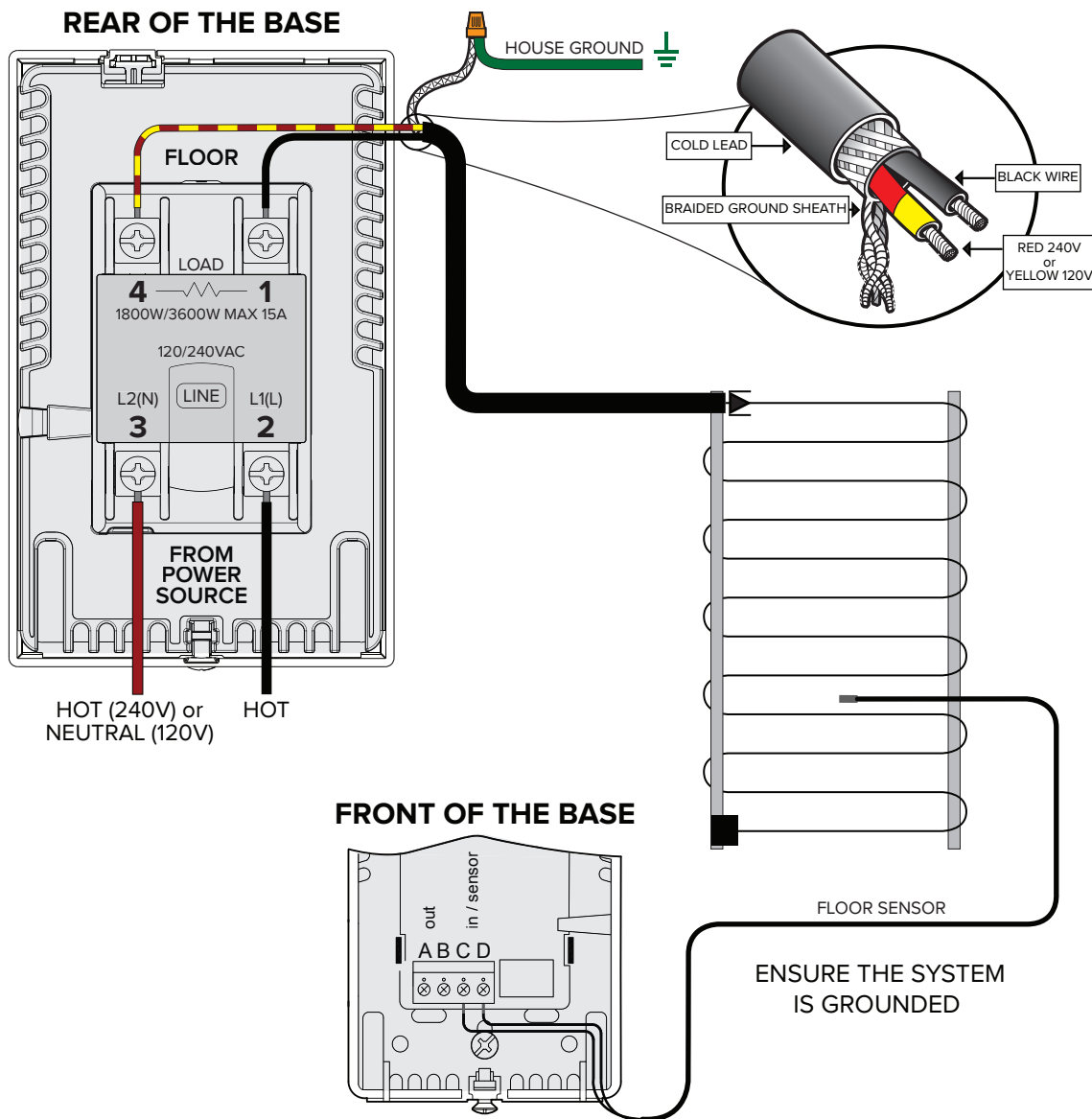
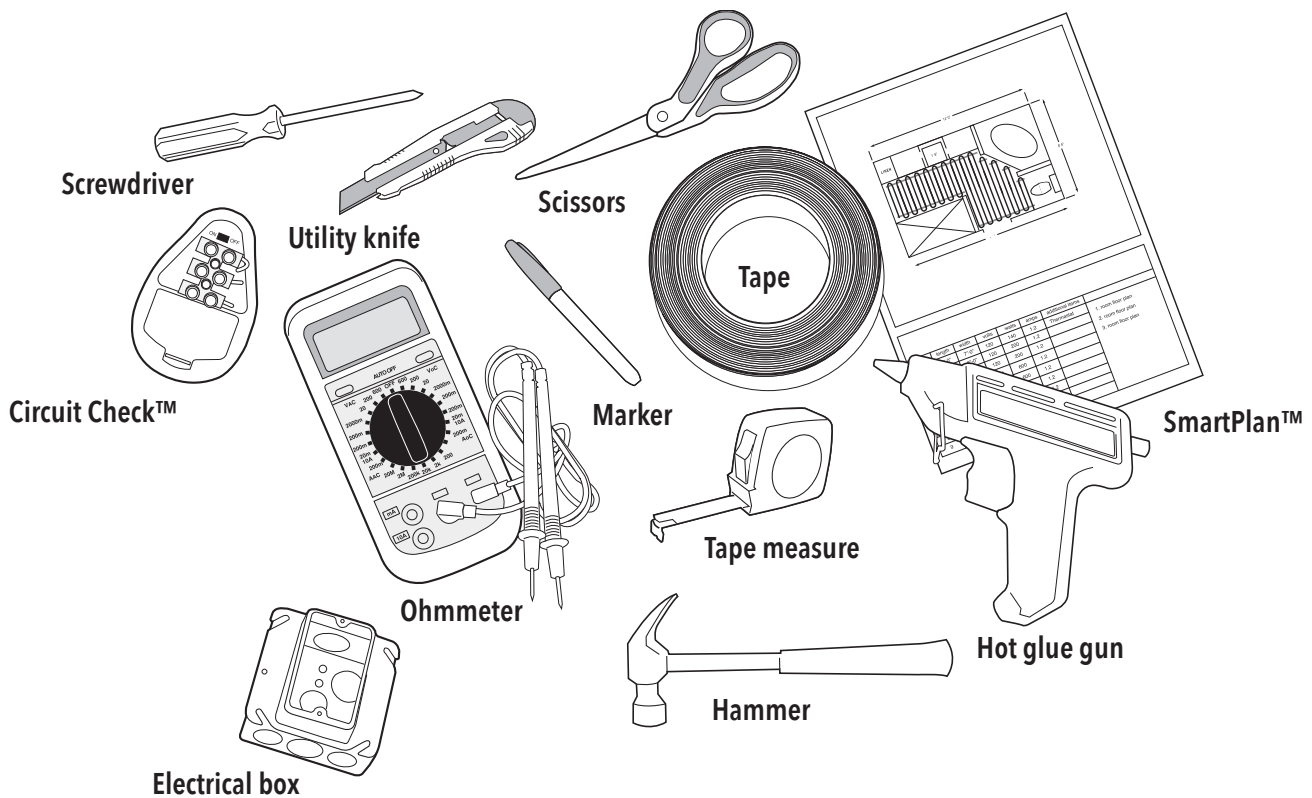

Figure 1. Wiring Diagram for 120V or 240V WarmlyYours TempZone™ Floor Heating Cable Installation

5.1 Recommended Equipment and Items for Installation

The following equipment and items are recommended for installation of the WarmlyYours TempZone™ Floor Heating Cable :

- Ohmmeter (or multimeter)
- Circuit Check™
- Hot glue gun (if using hot glue to secure the Cable Fixing Strips)
- Industrial-grade hot glue (if using hot glue to secure the Cable Fixing Strips)
- Chisel or router to create a groove for the splice in the subfloor
- Hammer
- Screwdriver
- Protective wall plate
- Duct tape or high temperature tape
- Staples, nails, adhesive or 1/2 inch screws to attach the Cable Fixing Strips to the subfloor
- Class-A Ground Fault Circuit Interrupter (if not using a WarmlyYours thermostat)
- Single-gang electrical box for each thermostat or power module
- Listed electrical conduit (to be provided by installer)
- Permanent marker
- Tape measure
- Utility scissors



5.2 Pre-Installation Preparation

- 5.2.1 Document the plan. Follow a SmartPlan™ obtained from WarmlyYours or prepare a floor plan of the area to be heated. Using a floor plan, with the TempZone™ Floor Heating Cable layout marked, makes it easy to trace the heating cable routing for troubleshooting if necessary.
- 5.2.2 Select the appropriate TempZone™ Floor Heating Cable, ensuring it is the correct length and voltage.
- 5.2.3 Identify a suitable location for installing the thermostat and low-voltage sensor if used.
- 5.2.4 Mark the layout of the floor heating cable on the floor plan. Taking photographs of the area may also be helpful.
- 5.2.5 Inspect the TempZone™ Floor Heating Cable visually and ensure that it is not damaged. Check voltage, wattage, and resistance values on the label.
- 5.2.6 Proper surface preparation of floor is extremely important. Make absolutely sure that there are no objects on the floor that might damage the TempZone™ Floor Heating Cable. Sweep the floor to ensure it is completely clear of debris, including nails, sharp metallic objects, wood, construction debris, and damaged or defective cables.
- 5.2.7 If applicable, install CeraZorb® on the concrete subfloor. Follow the manufacturer's instructions when installing the CeraZorb® insulating underlayment.
- 5.2.8 Check resistance of TempZone™ Floor Heating Cable with an ohmmeter upon removing it from the package. The resistance value of the heating cable should match the value on the label attached to the cable with a tolerance of -5/+10% allowed at 20° C (68° F). Record the resistance value on the warranty card in section 10.



IMPORTANT: The electrical resistance of the cable must be checked before you begin and monitored throughout the installation process to ensure there has been no damage causing shorts or breaks. WarmlyYours recommends at least three readings be taken:

1. Before starting installation
2. After securing the cable in place on the subfloor
3. After installing the flooring surface on top of the cable

- 5.2.9 Using an ohmmeter, check the insulation resistance of the cable between the core wires and to the ground wire. It should always read infinity.
- 5.2.10 Use a Circuit Check™ device during cable installation. These devices will provide an audible alarm if the wire is damaged or cut during installation. A continuity checker is not acceptable for these tests



IMPORTANT: Beware of Using a Continuity Checker!

For cables that have over 200 Ω resistance, some continuity checkers do not send enough current to get completely through the wire and emit the noise or light that affirms proper continuity. Please use a digital ohmmeter.

Three (3) ohm readings should be taken for each WarmlyYours TempZone™ Floor Heating Cable at each stage of the installation and recorded in the table on the warranty card in section 10. Refer to Figure 2 for instructions about how to attach the ohmmeter or PowerMan™ to take each type of reading.

1. Core to Core: This is the reading between the two inner conductors on the lead wires.
2. Core to Ground, Yellow / Red Lead: This is the reading between the inner core and the outer ground sheath on the lead wire. This reading should be infinity.
3. Core to Ground, Black Lead: This is the reading between the inner core and the outer ground sheath on the lead wire at the finish point of the cable. This reading should be infinity.

Ground Wire

Core to Sheath

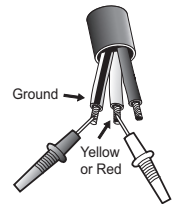

Core to Sheath

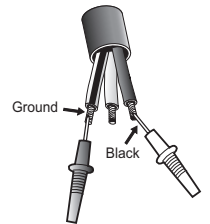

Core to Core

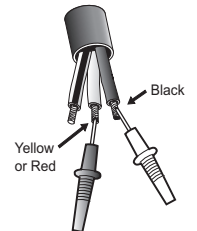

Ground Braid

Core to Sheath

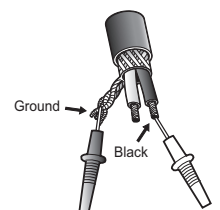

Core to Sheath

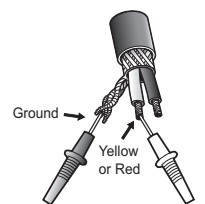

Core to Core

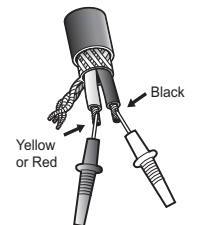

Figure 2. Attachment points for ohm readings

5.3 Circuit Check™ Instructions

5.3.1 Install TempZone™ Floor Heating Cable

Install the floor heating cable in accordance with the design layout and instructions provided by WarmlyYours.

5.3.2 Test the Circuit Check™

Before connecting any wires, install the batteries in the device and turn it on and off to test the alarm. After confirming that the alarm is in good working order, connect the wires as follows:

- Connect black inner conductor core wire to the black terminal
- Connect second inner conductor core wire to the red terminal

There are two ways of doing the next step:

1. Split the ground sheath in two. Connect one half of the ground sheath to the green terminal, turn on the Circuit Check™, and touch the other half of the ground sheath to one of the inner conductor wires.
2. Install the entire ground into the green terminal. Turn on unit and use a paper clip as a bridge between the ground wire and either one of the inner conductors.

Either method should activate the alarm. If the Circuit Check™ does not pass all these tests, please call WarmlyYours 24/7 Installation Support at (800) 875-5285 for assistance.

5.3.3 Activate the Circuit Check™ and Proceed to Install Flooring

5.3.4 If the Circuit Check™ Alarm Sounds, Stop!

If the alarm sounds, there is a short in the circuit or break in the system. Refer to the troubleshooting guide in section 8 of this installation manual or call 24/7 Installation Support at (800) 875-5285.

WarmlyYours can ship a splice kit to repair the short. Alternatively, the wire may be repaired by an electrician. Please see the wire repair documents "Instructions for Twin Conductor TempZone™ Repair" at www.warmlyyours.com/publications/TZ-TWIN-REPAIR-30027-B/download and "TempZone™ Cut & Turn Twin Conductor Solder Method Wire Repair" at www.warmlyyours.com/publications/TZ-TWIN-SOLDER-REPAIR-30028-A/download or call us 24/7 at (800) 875-5285.

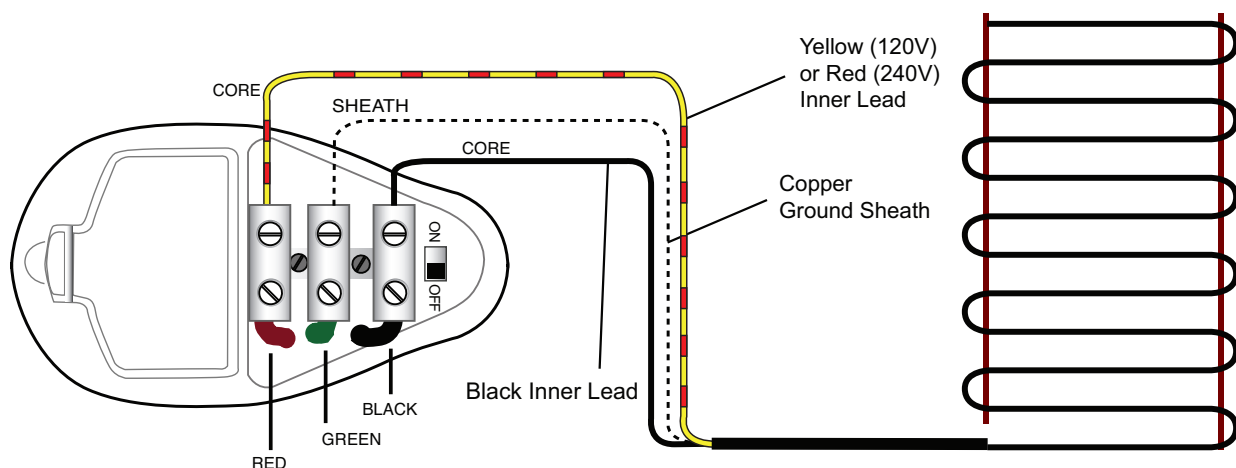

Figure 5. How to connect the Circuit Check™ for installation

5.4 Installation of TempZone™ Floor Heating Cable

5.4.1 Install TempZone™ Cable Fixing Strips

Install Cable Fixing Strips in a direction perpendicular to the direction the cable will run. Cable Fixing Strips should be installed at least 3 inches from the wall perimeter. WarmlyYours recommends securing the cable to the floor every 20 inches using tape or hot glue to keep the cable in position until the self-leveling underlayment is applied. When working around cabinets or vanities, install the Cable Fixing Strips at a distance that will allow the cable to be installed 1-1/2 inches away from the cabinet or vanity base.

Each row of Cable Fixing Strips should be positioned at the appropriate intervals to ensure the desired OC spacing (3 or 4 inches) for the installation.

Secure the Cable Fixing Strips to the floor. There are several acceptable methods for doing so.

For plywood, cement board, or similar surfaces:

- Secure Cable Fixing Strip with galvanized nails or screws.

For concrete or similar surfaces:

- Concrete nails are recommended for best results.
- Double-sided tape, hot glue, or a strong spray adhesive may be used if the floor is thoroughly cleaned and the Cable Fixing Strips are cleaned to remove any oils.
- If spray adhesive is used, be sure to carefully follow all of the manufacturer's instructions. WarmlyYours recommends applying the spray adhesive to both the back of the Cable Fixing Strip and the floor.

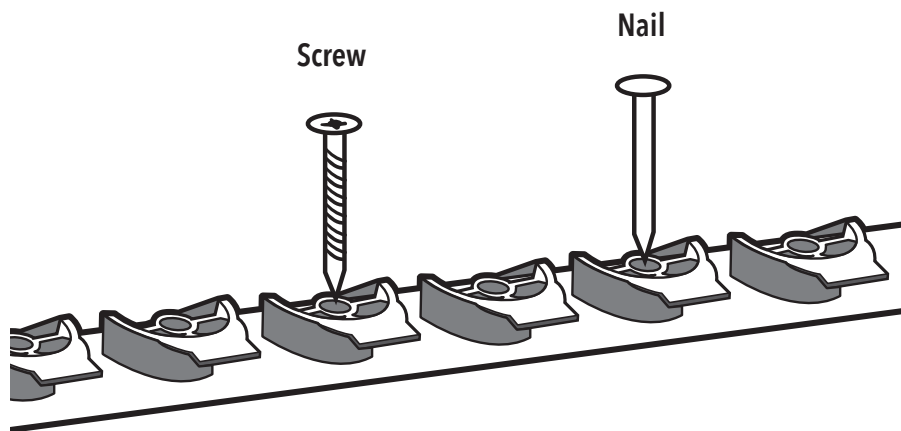



Figure 6. Securing the Cable Fixing Strips

5.4.2 Install the TempZone™ Floor Heating Cable

1. Begin installing the heating cable from the thermostat or junction box. Follow the pattern marked on the floor plan (if supplied). Please note the thickness of the factory splice and cold lead and plan accordingly.
2. Unwind the cable from the spool. Secure it using the TempZone™ Cable Fixing Strips. Avoid bunching the cable or crossing over other parts of the cable.
3. The TempZone™ Floor Heating Cable should be installed in a uniformly-spaced serpentine pattern. Refer to either "Product Selection Guide--120V" or "Product Selection Guide--240V" in section 9 for spacing information.
4. Take note of the cable's halfway point marking indicated on the cable. This mark should match the halfway point indicated on the custom SmartPlan™ supplied with the order (optional).
5. Route the power leads from the floor to the thermostat box. If using multiple heating cables, route the power leads from the floor to a junction box or thermostat box in the wall.

 *NOTE: Leads should be protected at the point they leave the floor. Rigid metal conduit, intermediate metal conduit, rigid nonmetallic conduit, electrical metallic tubing, or other means approved by local electrical codes should be used.*

6. For installations including a thermostat, the low-voltage floor sensor should be placed in between the loops created by the cable and held in place with a small amount of thinset or hot glue. See Figure 7.

The sensor wire cannot cross any heating cable or lead wire. It must extend at least 6 inches into the heated area. The sensor and its wire should be covered directly with thinset or self-leveling underlayment.

The cold lead wires should be placed above the subfloor, along the side of the heated area at least 2 inches from the heating wire. Secure the cold lead wires with a suitable tape or hot glue before the thinset or self-leveling underlayment is applied over the cables.

7. Use an ohmmeter check the continuity, insulation resistance, and resistance values again after the cable has been installed. Compare these post-installation values with pre-installation values to ensure they are consistent. Record post-installation values on the warranty card in section 10.

Attach Circuit Check™ to cold leads at this time.

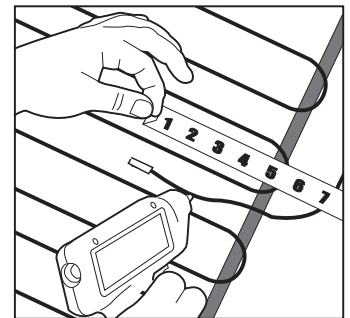

Figure 7. Placement of the floor temperature sensor

8. Apply thinset or self-leveling compound over the heating cable and subfloor. Acrylic, latex, or polymer-modified thinset cement may be used. Ensure that the material you select is compatible with the flooring material. Contact the adhesive manufacturer for more information and curing times.

Ensure that there are no air gaps during application of thinset or self-leveling underlayment (SLU). Make sure the heating cable, factory splices, and low-voltage thermostat sensor (if used) are completely embedded in the thinset or SLU. If SLU is used, be sure to use any primer required by the manufacturer.

A single- or double-layer method may be used over any subfloor (plywood, cement slab, concrete backer board, or mud bed). These methods are suitable for any stone or tile floor covering. For carpet (U.S. only), vinyl or laminate floor coverings, WarmlyYours recommends covering the floor heating system with 3/8 inch of self-leveling underlayment (total depth, whether the single- or double-layer application method is used) to create a smooth surface for installing these types of flooring. Follow the instructions appropriate to the type of floor covering to be used.



CAUTION: Careless use of the trowel can damage the heating cable. Never drop or bang a trowel directly on the cable.

5.4.3 Instructions for Installation in Wet Locations

1. Installation shall be in accordance with the National Electrical Code, NFPA-70 and CAN/CSA- C22.1, Canadian Electrical code (CEC), Part 1 and that final acceptance is to be made in the field by the Authority Having Jurisdiction (AHJ).
2. WarmlyYours recommends using a separate heating cable for shower areas. Note: The UL Listing for this product does not cover use in wet locations in the United States. Installations shall be in accordance with the National Electric Code, NFPA 70 and any other applicable jurisdictional codes and final acceptance is to be made by the Authority Having Jurisdiction (AHJ).
3. If insulation board is being used over a slab, use suitable glue or cement-based adhesive, or thinset mortar to adhere it to the slab. If installing in a wet location, ensure the slope of the mortar bed is maintained so that it directs water to the drainpipe.

1. Weave the cable back and forth across the area at the desired spacing. Maintain slight tension on the cable to ensure it does not pull loose. If desired, use hot glue at intervals to help ensure it stays secure. NEVER space the cables less than 3" apart.

RPM Mats

3" Spacing

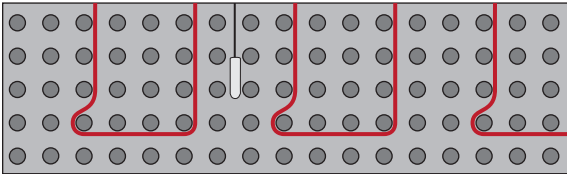

3.5" Spacing

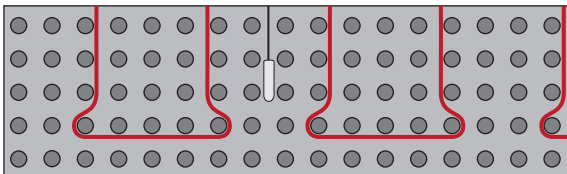

Schluter Ditra-Heat (3.5") or Prodeso Mats (3.75") Spacing

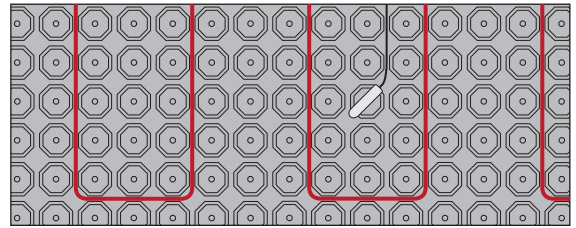

2. Mark where the factory splice will be placed. Cut the matting or membrane and insert splice. It may be necessary to secure the splice to the floor with hot glue, adhesive or thinset.

3. Embed the heating cable between studs, at a spacing of 3 studs. Closer spacing may result in overheating and damage to building structures. A wider spacing may not provide sufficient power to warm the floor.

4. Cable must be turned or a u-shaped "jog" created at every 10ft (3m) of cable run.

5. Continue to lay out the cable until the cable end cap is reached. Mark final location of end cap. Cut the matting or membrane and insert the end cap. It may be necessary to secure the end cap to the floor with hot glue, adhesive or thinset.

6. Always remember to install the thermostat sensor (if applicable) 6" into an open loop of the heating wire. Cut into membrane as shown.

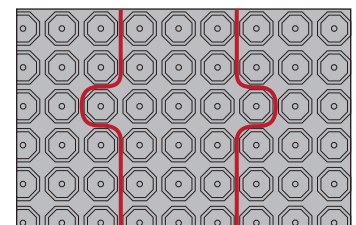
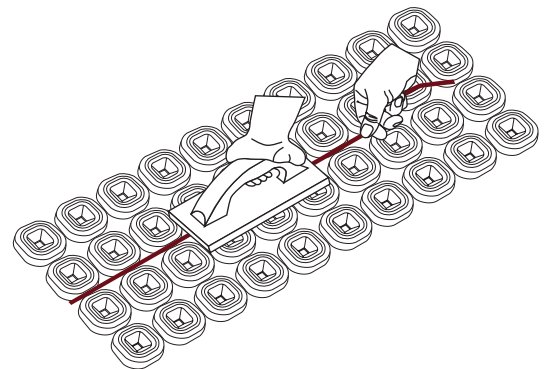
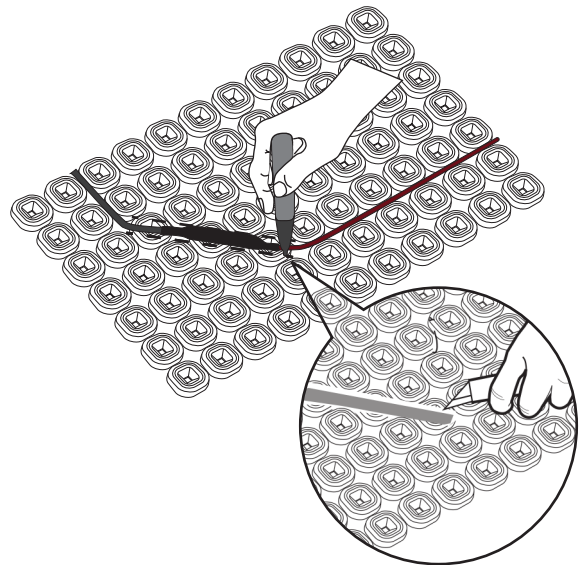

5.4.4 Instructions for Installation Under Tile and Stone Flooring

Option 1: Single-layer method for tile and stone

Apply a layer of 3/8 inch latex-modified thinset cement or self-leveling underlayment (SLU) over the heating cable. Lay the tile or stone directly into that layer of thinset cement.

OR

Option 2: Double-layer method for tile and stone

Embed the heating cable in a skim coat of latex-modified thinset or self-leveling underlayment, completely covering the heating element and the sensor wire. Apply a second layer of thinset and lay tiles as usual. The recommended depth for both layers of thinset or SLU is 3/8 inch.

The single-layer method is used most by experienced installers in small applications with easy access. WarmlyYours does NOT recommend the single-layer method for installing mosaics or tiles of different sizes or if you have not installed an electric radiant heating system under tile or stone before.

Waiting Period: Regardless of method used, installation of floor heating cable under tile or stone requires 2 to 28 days for the latex-modified thinset or self-leveling underlayment to cure. Follow manufacturer recommendations for cure times applicable to your installation.



IMPORTANT: Do NOT turn on the WarmlyYours TempZone™ Floor Heating Cable system until after the thinset or self-leveling underlayment (SLU) has fully cured. Doing so will result in damage to the system and cause the thinset or SLU to become brittle. Failure of the thinset or SLU may cause damage to the embedded cable. This type of damage is not covered by the WarmlyYours warranty.

5.4.5 Instructions for Installation Under Carpet, Vinyl, or Laminated Flooring

Before applying SLU, ensure that the cable is firmly secured to the subfloor to prevent it from floating to the top of the self-leveling underlayment. Attach the Circuit Check™ at this time. Cover cable with 3/8 inch layer of self-leveling underlayment.

5.4.6 Instructions for Installation Under Hardwood Flooring



Note : Although TempZone™ Floor Heating Cable is approved for direct contact with combustible material, WarmlyYours strongly recommends that the cable be embedded in thinset, self-leveling underlayment, cement-based adhesive glue, or tile adhesive under wood flooring surfaces.

STEP 1: Install wood sleepers

Using nails, adhesive, or other acceptable means of attachment, install wood sleepers (strips of wood 1 to 2 inches wide and 3/8 to 1/2 inch high) at intervals 19 inches apart, or distance specified by the flooring manufacturer, perpendicular to the planned direction of hardwood boards.

The plywood subfloor must leave appropriate spacing and gaps for any planned runs of cable to other heated areas. The sleepers are fixed in such a manner that they create a required gap between two sleepers in which the warming system can be installed.

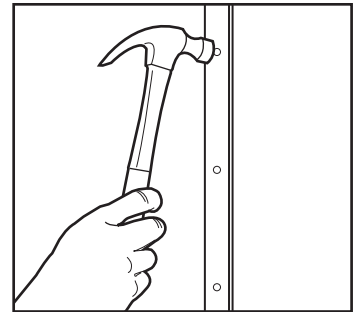

STEP 2: Install the floor warming system

Install Cable Fixing Strips as described in section 5.5.1. Using the Cable Fixing Strips to secure the cable, install the floor warming system into the gap created by the sleepers. Carefully return the power leads to the power supply alongside the warming system and wood sleepers. Attach PowerMan™ and Circuit Check™ to the cold leads at this time. Refer to section 5.3 for PowerMan™ instructions and section 5.4 for Circuit Check™ instructions.

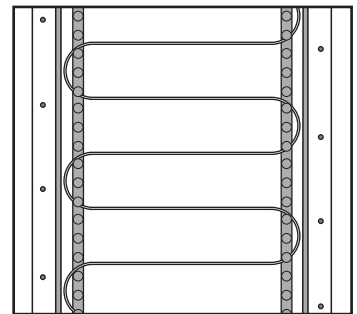

STEP 3: Cover the floor warming system with self-leveling compound

After the warming system has been put in place, it should be covered with self-leveling compound up to the height of the sleepers. Do not cover the sleepers. The tops of the sleepers should remain uncovered and visible.

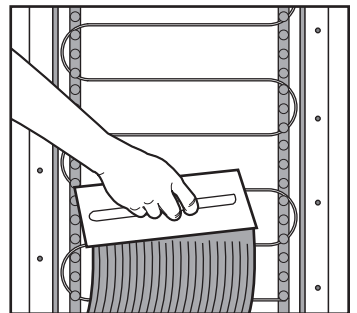

STEP 4: Install hardwood flooring

Allow the appropriate time for the self-leveling compound to completely dry and cure. After the compound has dried and cured, install the hardwood flooring. The hardwood floor can be installed by nailing it to the wood sleepers. Be careful not to place nails or staples near the system's heating cable or power lead.

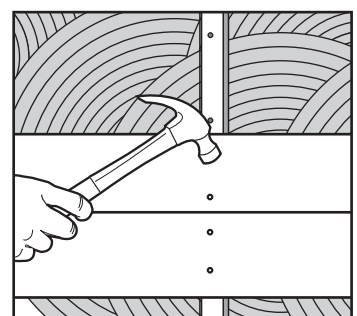

6.1 Testing the Cable



IMPORTANT: Do NOT supply the system with electric current to test.

All testing should be done with a digital ohmmeter. Supplying the system with a 120V or 240V electric current before the installation is complete is not needed to test the system.

6.2 Take the Ohm Readings

The electrical resistance of the WarmlyYours TempZone™ Floor Heating Cable must be checked before you start and monitored throughout the installation process to ensure there has been no damage causing shorts or breaks. We recommend at least three readings be taken:

1. Before starting installation
2. After securing the cable in place on the subfloor
3. After installing the flooring surface on top of the cable

Use an ohmmeter to measure the resistance.

6.3 Record the Ohm Readings

The value on the UL label should be within -5/+10% variance at 20°C (68°F) of the original measurement indicated on the label. The electrician should carefully mark the initial ohm reading taken onto the warranty card in section 10. Should the initial ohm reading be outside the -5/+10% variance, refer to section 8, Troubleshooting, or call WarmlyYours Technical Support at (800) 875-5285.

The specified resistance value and other important information can be found on the WarmlyYours TempZone™ Floor Heating Cable product label. Figure 8 depicts a sample product label. The information provided in the figure is for illustration purposes only. Refer to label included with the cable for actual values.

ENREGISTRE LISTED WarmlyYours TempZone™ Floor Heating Cable (Twin) UNITE DE PLANCHER CHAUFFANT ELECTRIQUE XXXX		 WarmlyYours TempZone™ Floor Heating Cable (Twin) Plancher Chauffant Electrique For Installation in an adhesive bed, self leveling or mortar cement Installation avec ciment, mortier colle ou colle a carrelage	
Catalog Number : TRT120-1.5 x 04 Resistance / Ohm : Core to Core : 160.0 Ohm Tension a Tension : Grid Sheath to Grid Sheath : N.A. Prise de terre a Pdt. : N.A. Output Unit W Puissance de l'unité : 90 Watt Spéc. output W / sqft Puissance au pied carre : 15 W Voltage : 120 V/ 60 Hz Usage Marking : - X	Length / ft : 4' Longueur en pieds : 4' Width / ft : 1.5' Largeur en pieds : 1.5' S.No. : 12345 A		
REFER TO INSTALLATION INSTRUCTIONS *CAUTION : a ground fault protection device must be used With this heating device* *ATTENTION : ce produit doit être utilisé avec une protection de mise à la terre* *DO NOT CUT THE HEATING WIRE OR SHORTEN THE ROLL* *NEVER CONNECT DIRECTLY TO ANOTHER HEATING ROLL*			

Ohm value (points to Resistance / Ohm)

A ground fault protection device must be used with this heating device. (points to CAUTION text)

QR code contains all information about the system. Use a smart phone to scan QR code and access information. (points to QR code)

Figure 8. Sample product label

6.4 Go by the Numbers

The resistance should be measured from the inner core of the yellow (120V) or red (240V) lead wire at one end to the inner core of the black lead wire at the other end. Make sure that the probe of the ohmmeter does not touch the tinned sheath wire at either end. Do not hold the wires onto the probes with your fingers. Even your body's electrical resistance can affect the reading if you touch the meter poles. A digital meter is easier to use and strongly recommended. Verify that the batteries of the ohmmeter are good. Set your ohmmeter to measure resistance in the range of 0 to 200 Ω .

For cables that have over 200 Ω resistance, it may be necessary to set the ohmmeter to the next higher range of measurement to get an accurate ohm reading.

Three (3) ohm readings should be taken for each WarmlyYours TempZone™ Floor Heating Cable at each stage of the installation and recorded in the table on the warranty card in section 10. Refer to Figure 9 for instructions about how to attach the ohmmeter or PowerMan™ to take each type of reading.

1. Core to Core: This is the reading between the two inner conductors on the lead wires.
2. Core to Sheath, Yellow / Red Lead: This is the reading between the inner core and the outer ground sheath on the lead wire. This reading should be infinity.
3. Core to Sheath, Black Lead: This is the reading between the inner core and the outer ground sheath on the lead wire at the finish point of the cable. This reading should be infinity.

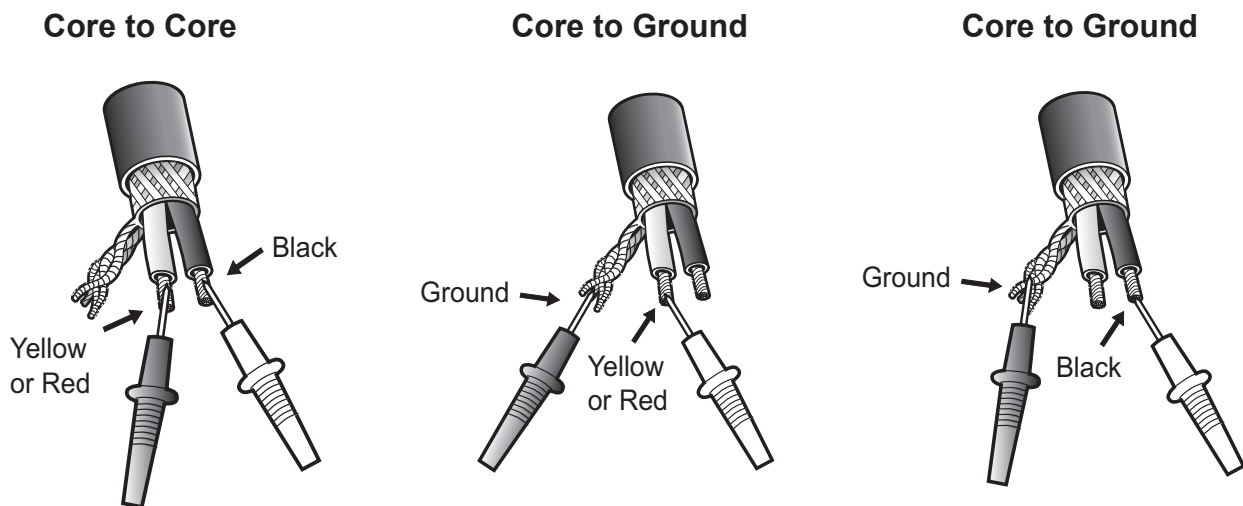

*The ground wire may differ from the images above.
The ground wire may be represented as a additional wire with a stripe.
The testing procedure is still performed the same way.*

Figure 9. Attachment points for ohm readings

7.1 Operating Tips

- 7.1.1 When first energized, the TempZone™ Floor Heating Cables may take approximately 1 to 3 hours or more to fully warm your floor. Heating results will vary depending on climate and building materials.
- 7.1.2 Energy consumption will vary depending on user preferences. To reduce energy consumption, set the thermostat to a lower temperature setting or operate for a shorter duration.
- 7.1.3 Energy consumption can be minimized by turning the system off when floor heat is not required. However, additional time will be needed for the floor to warm up when the system is turned on again.
- 7.1.4 WarmlyYours recommends and offers thermostats with a setback option. This option reduces warm-up time by setting the system to operate at a lower floor temperature, instead of completely turning it off, during the setback period(s).
- 7.1.5 Avoid placing thick mats, rugs, mattresses, and broad-based or box-bottomed furniture on the heated floor, especially where the floor temperature sensor is located. These objects restrict the transfer of heat away from the cables and trap heat. This causes the floor beneath the object to become warmer than other areas in the room. Trapped heat may also cause discoloration or damage to some floor covering materials.
- 7.1.6 Avoid using mats with rubber or vinyl backing, as the heat may cause them to decompose and stain the floor covering.
- 7.1.7 When heating a hardwood floor, the flooring manufacturer may require that the floor be kept at a steady temperature, without a setback. Please consult the flooring manufacturer for any requirements to radiant heating.

8.1 Identify the Problem

If the system is not functioning properly, refer to the "Quick Reference Troubleshooting Guide" to determine the cause of the problem.

Quick Reference Troubleshooting Guide

Ohm Reading	What It Indicates	What to Do Next
Zero	Open circuit or short	Obtain ShortStop fault finder* from WarmlyYours to check distance to break.
Lower than the acceptable range, but some continuity is present	Ohmmeter batteries may be low	Replace batteries and take ohm readings again.
	Multiple electrical shorts	Obtain ShortStop fault finder* from WarmlyYours. Take a reading between each core wire and ground to determine the location of the short.
Within range (-5/+10%) of specified value on UL label	No break	Check for an electrical short.
Higher than acceptable range	Possible short	Obtain ShortStop fault finder* from WarmlyYours. Take a reading between each core wire and ground to determine the location of the short.
Infinity	Ohmmeter may be set to incorrect scale	Set ohmmeter to correct scale and test again. (Correct scale settings: 0 to 200 Ω for cable; 0 to 20,000 Ω for sensor wire)
	Possible short	Obtain ShortStop fault finder* from WarmlyYours. Take a reading between each core wire and ground to determine the location of the short.
	Possible break	Contact WarmlyYours for assistance.

*Note: A floor plan with the layout of the installation is required to determine the location of the short. For installations without a plan, please contact WarmlyYours technical support at (800) 875-5285.

8.2 Troubleshooting

8.2.1 Locating a Fault in the TempZone™ Floor Heating Cable

Use a Circuit Check™ device during cable installation. These devices will provide an audible alarm if the wire is damaged or cut during installation. A continuity checker is not acceptable for these tests.

Beware of Using a Continuity Checker!

With cables that have over 200 Ω resistance, some continuity checkers do not send enough current to get completely through the wire and emit the noise or light that affirms proper continuity. For this reason, we always recommend using a digital ohmmeter for any product testing or troubleshooting.

After the installation, if necessary, the position of a break can be found with the WarmlyYours Troubleshooting Kit. A time domain reflectometer (ShortStop) will not be able to find a break without an installation plan. Repair kits and guidance are available from WarmlyYours 24/7 Technical Support at (800) 875-5285, or go to www.WarmlyYours.com/support for additional information.

8.2.2 Electrical Fault Finding

If the system is not functioning properly, turn off the system and have a licensed, certified electrician perform the following:

- Complete all steps of the installation process.
- Verify that all wiring connections, including grounding of the system, are correct.
- Check the sensor wire for proper ohm reading.
- Ensure all wires have been connected, including grounding of the system, in accordance with the wiring diagrams.
- Verify that the breaker supplying power to the WarmlyYours thermostat is a non-GFCI circuit breaker (Note: If using a thermostat not provided by WarmlyYours, a GFCI-circuit breaker may be required).
- Make sure multiple cables have been wired in parallel and not in series.
- Confirm that the thermostat is receiving the correct voltage and outputting the same voltage when calling for heat.
- Using a well-calibrated, digital ohmmeter with good batteries, check the ohm resistance level of each heating cable. Refer to sections 5.2.10 and 5.3 for instructions about how to attach the ohmmeter. Verify that these values are within -5%/+10% at 20°C (68°F) of the resistance value listed on the product label. If the measured values exceed the acceptable range, refer to the "Quick Reference Troubleshooting Guide" in section 8.1. If the measured value is not within range of the original reading, the cable may have been damaged in some way during installation.

If all of the above items have been completed and the system is still not operating correctly, then determine if there is a break or a short under the floor.

8.2.3 Checking for Breaks or Shorts

To check for a break, measure the ohm resistance of each cable. When taking an ohm reading, ensure that you do the following:

- Do not touch either of the probe ends with any part of your body. If the probe end is in contact with the body, the meter will measure the internal resistance of your body, not the cable.
- Set ohmmeter to the proper scale (0 to 200 Ω for heating cable or 0 to 20,000 Ω for the sensor wire).

The ohm resistance readings should be within -5%/+10% at 20°C (68°F) of the nominal resistance indicated by the factory on the UL label. Refer to the "Quick Reference Troubleshooting Guide" in section 8.1. to determine what the ohm readings indicate.

Additional Information for Identifying Electrical Shorts

In some rare occasions during installation, a high pressure point on the cable can occur and cause a break in the insulation between the core conductor and the metal sheath. This opening in the insulation layer can create an electrical short, even though the ohm reading from one line conductor to the other line conductor is normal and does not indicate a circuit break. In these rare circumstances, a continuity test will show no continuity (a reading of infinity) between the line conductor and the ground wire and/or between the other line core conductor and the ground. A megaohm meter can be used to test the wire insulation in these cases.

There should be no continuity (indicated by a resistance reading of infinity, not zero) between each line conductor and ground. If the ohmmeter or PowerMan™ reveals continuity between both the line conductor and ground, there is a short in the circuit.

8.2.4. Checking for Breaks or Shorts Using an Underground Fault Detector

There are two ways to locate breaks or electrical shorts with underground fault detectors:

1. A break or short can most easily be found with a high potential (hipot) insulation tester, a high-voltage generating device that generates a ground or heat at the break point. The hipot can be used with infrared cameras to scan the floor and detect the exact location of the break. Contact WarmlyYours for more information about renting our troubleshooting kit.
2. A break or short can sometimes be found with a time domain reflectometer (ShortStop fault finder), which measures the distance of the wire between the tester and the short point. A floor plan with the layout of the installation is required to determine the location of the short.

Product Selection Guide 120V

PRODUCT CODE	Heating Cable Length	Power	Total Resistance in Ω @20°C (68°F)	Current	3-inch Spacing			4-inch Spacing		
					Total Cable Coverage (sq. ft.)*	Total No. of Cable Guides (rounded)	Watts per Square Foot	Total Cable Coverage (sq. ft.)*	Total No. of Cable Guides (rounded)	Watts per Square Foot
	Feet	Watts	Nom	Amps						
TCT120-3W-030	30	90	160.00	0.75	9	9	10	12	12	8
TCT120-3W-040	40	120	120.00	1.00	11	12	11	15	12	8
TCT120-3W-050	50	150	96.00	1.25	14	12	11	19	20	8
TCT120-3W-070	70	210	68.57	1.75	19	20	11	25	20	8
TCT120-3W-090	90	270	53.33	2.25	25	20	11	32	24	8
TCT120-3W-120	120	360	40.00	3.00	32	24	11	43	35	8
TCT120-3W-150	150	450	32.00	3.75	40	35	11	53	40	8
TCT120-3W-180	180	540	26.67	4.50	48	35	11	63	48	9
TCT120-3W-220	220	660	21.82	5.50	58	48	11	77	54	9
TCT120-3W-260	260	780	18.46	6.50	68	54	11	90	70	9
TCT120-3W-300	300	900	16.00	7.50	78	54	12	104	77	9
TCT120-3W-340	340	1020	14.12	8.50	89	70	11	117	88	9
TCT120-3W-375	375	1125	12.80	9.38	97	70	12	129	96	9
TCT120-3W-432	432	1296	11.11	10.80	112	77	12	148	104	9
TCT120-3W-468	468	1404	10.26	11.70	121	88	12	161	117	9

*Based on a square room with an unheated border of 3 inches

Product Selection Guide 240V

PRODUCT CODE	Heating Cable Length		Power	Total Resistance in Ω @20°C (68°F)	Current	3-inch Spacing			4-inch Spacing		
	Feet	Watts				Nom	Amps	Total Cable Coverage (sq. ft.)*	Total No. of Cable Guides (rounded)	Watts per Square Foot	Total Cable Coverage (sq. ft.)*
	TCT240-3W-055	55	165	349.09	0.69	15	12	11	20	20	8.3
TCT240-3W-065	65	195	295.38	0.81	18	20	11	24	20	8.1	
TCT240-3W-075	75	225	256.00	0.94	21	20	11	27	24	8.3	
TCT240-3W-095	95	285	202.11	1.19	26	24	11	34	30	8.4	
TCT240-3W-115	115	345	166.96	1.44	31	24	11	41	35	8.4	
TCT240-3W-155	155	465	123.87	1.94	41	35	11	55	48	8.5	
TCT240-3W-195	195	585	98.46	2.44	52	40	11	68	54	8.6	
TCT240-3W-235	235	705	81.70	2.94	62	48	11	82	70	8.6	
TCT240-3W-275	275	825	69.82	3.44	72	54	11	95	70	8.7	
TCT240-3W-315	315	945	60.95	3.94	82	70	12	109	77	8.7	
TCT240-3W-355	355	1065	54.08	4.44	92	70	12	122	88	8.7	
TCT240-3W-395	395	1185	48.61	4.94	103	77	12	136	96	8.7	
TCT240-3W-435	435	1305	44.14	5.44	113	77	12	150	104	8.7	
TCT240-3W-515	515	1545	37.28	6.44	133	96	12	177	126	8.7	
TCT240-3W-595	595	1785	32.27	7.44	153	117	12	204	150	8.8	
TCT240-3W-675	675	2025	28.44	8.44	174	126	12	231	160	8.8	
TCT240-3W-749	749	2247	25.63	9.36	192	126	12	255	176	8.8	
TCT240-3W-864	864	2592	22.22	10.80	221	150	12	294	198	8.8	
TCT240-3W-935	935	2805	20.53	11.69	239	160	12	318	216	8.8	

*Based on a square room with an unheated border of 3 inches

Product Selection Guide 120V

PRODUCT CODE	Heating Cable Length	Power	Total Resistance in Ω @20°C (68°F)	Current	3-inch Spacing			4-inch Spacing		
	Feet	Watts	Nom	Amps	Total Cable Coverage (sq. ft.)*	Total No. of Cable Guides (rounded)	Watts per Square Foot	Total Cable Coverage (sq. ft.)*	Total No. of Cable Guides (rounded)	Watts per Square Foot
TCT120-3.7W-030	30	111.0	129.73	0.93	8.9	9.00	12.4	11.6	16.00	9.5
TCT120-3.7W-040	40	148.0	97.30	1.23	11.6	16.00	12.7	15.2	16.00	9.7
TCT120-3.7W-050	50	185.0	77.84	1.54	14.3	16.00	12.9	18.8	20.00	9.9
TCT120-3.7W-070	70	259.0	55.60	2.16	19.7	20.00	13.2	25.8	30.00	10.0
TCT120-3.7W-090	90	333.0	43.24	2.78	24.9	20.00	13.4	32.8	30.00	10.2
TCT120-3.7W-120	120	444.0	32.43	3.70	32.8	30.00	13.5	43.2	42.00	10.3
TCT120-3.7W-150	150	555.0	25.95	4.63	40.6	42.00	13.7	53.6	48.00	10.4
TCT120-3.7W-180	180	666.0	21.62	5.55	48.4	42.00	13.8	63.9	48.00	10.4
TCT120-3.7W-220	220	814.0	17.69	6.78	58.8	48.00	13.9	77.7	63.00	10.5
TCT120-3.7W-260	260	962.0	14.97	8.02	69.1	63.00	13.9	91.4	70.00	10.5
TCT120-3.7W-300	300	1,110.0	12.97	9.25	79.4	63.00	14.0	105.1	88.00	10.6
TCT120-3.7W-340	340	1,258.0	11.45	10.48	89.7	70.00	14.0	118.7	88.00	10.6
TCT120-3.7W-375	375	1,388.0	10.37	11.57	98.7	70.00	14.1	130.6	108.00	10.6
TCT120-3.7W-432	432	1,598.0	9.01	13.32	113.3	88.00	14.1	150.1	117.00	10.6

*Based on a square room with an unheated border of 3 inches

Product Selection Guide 240V

PRODUCT CODE	Heating Cable Length	Power	Total Resistance in Ω @20°C (68°F)	Current	3-inch Spacing			4-inch Spacing		
	Feet	Watts	Nom	Amps	Total Cable Coverage (sq. ft.)*	Total No. of Cable Guides (rounded)	Watts per Square Foot	Total Cable Coverage (sq. ft.)*	Total No. of Cable Guides (rounded)	Watts per Square Foot
TCT240-3.7W-055	55	204.0	283.05	0.85	15.7	16.00	13.0	20.5	20.00	9.9
TCT240-3.7W-065	65	241.0	239.50	1.00	18.3	20.00	13.1	24.1	20.00	10.0
TCT240-3.7W-075	75	278.0	207.57	1.16	21.0	20.00	13.2	27.6	30.00	10.1
TCT240-3.7W-095	95	352.0	163.87	1.46	26.2	30.00	13.4	34.5	30.00	10.2
TCT240-3.7W-115	115	426.0	135.37	1.77	31.5	30.00	13.5	41.5	42.00	10.3
TCT240-3.7W-155	155	574.0	100.44	2.39	41.9	42.00	13.7	55.3	48.00	10.4
TCT240-3.7W-195	195	722.0	79.83	3.01	52.3	48.00	13.8	69.1	63.00	10.4
TCT240-3.7W-235	235	870.0	66.24	3.62	62.6	48.00	13.9	82.8	70.00	10.5
TCT240-3.7W-275	275	1,018.0	56.61	4.24	73.0	63.00	13.9	96.5	70.00	10.5
TCT240-3.7W-315	315	1,166.0	49.42	4.86	83.2	70.00	14.0	110.2	88.00	10.6
TCT240-3.7W-355	355	1,314.0	43.85	5.47	93.5	70.00	14.0	123.8	108.00	10.6
TCT240-3.7W-395	395	1,462.0	39.41	6.09	103.8	88.00	14.1	137.5	108.00	10.6
TCT240-3.7W-435	435	1,610.0	35.79	6.71	114.0	88.00	14.1	151.1	117.00	10.7
TCT240-3.7W-515	515	1,906.0	30.23	7.94	134.5	108.00	14.2	178.3	140.00	10.7
TCT240-3.7W-595	595	2,202.0	26.16	9.17	154.9	117.00	14.2	205.4	150.00	10.7
TCT240-3.7W-675	675	2,498.0	23.06	10.41	175.3	140.00	14.2	232.6	176.00	10.7
TCT240-3.7W-749	749	2,771.0	20.78	11.55	194.2	140.00	14.3	257.6	204.00	10.8
TCT240-3.7W-864	864	3,197.0	18.02	13.32	223.4	165.00	14.3	296.5	216.00	10.8

*Based on a square room with an unheated border of 3 inches

Please complete and return the warranty card

Thank you for purchasing your new WarmlyYours TempZone™ Floor Heating Cable. To register your system, go online to www.warmlyyours.com/floor-heating/twin-cable/warranty, or simply complete, detach and mail this warranty card within 30 days of date of purchase to: WarmlyYours, 590 Telsler Rd., Lake Zurich, IL 60047. For your convenience, you may also fax this card to (800) 408-1100. WarmlyYours recommends that you make a copy for your records.

System Warranty Registration Card

1. HOMEOWNER INFORMATION		
Name		Phone
Address	Email	
City	State	Postal/Zip Code
Fax		

2. FLOOR INSTALLER INFORMATION		Check here if homeowner installed <input type="checkbox"/>
Company Name		Phone
Address	Email	
City	State	Postal/Zip Code
Fax		

3. ELECTRICIAN INFORMATION		
Company Name		Phone
Address	Email	
City	State	Postal/Zip Code
Fax		

4. HEATING SYSTEM INFORMATION		Cable Length	Final Ohm Reading
Install Date		Cable 1	
Installed Under: <input type="checkbox"/> Tile <input type="checkbox"/> Stone <input type="checkbox"/> Laminate Wood <input type="checkbox"/> Other		Cable 2	
(Please specify other) _____		Cable 3	
Subfloor Material		Cable 4	
Set In		Cable 5	
Total Cable Installed		Cable 6	
		Cable 7	

Terms and Conditions

WarmlyYours, Inc. warrants the WarmlyYours TempZone™ Floor Heating Cable electric floor warming system (“the Product”) to be free from defects in materials and workmanship for twenty-five (25) years from the date of sale, provided that the Product is installed in accordance with the WarmlyYours product installation manual, any special written or oral design or installation guidelines provided by WarmlyYours for the specific project that the Product is intended, the provisions of the National Electrical Code (NEC), or Canadian Electrical Code (CEC) and all applicable local building and electrical codes. If the Product is determined to be defective in materials and workmanship, and has not been damaged as a result of misuse, misapplication or improper installation, WarmlyYours will, at the customer’s discretion, either refund the original cost of the Product or reimburse the cost for any labor and materials required to perform the repair or replacement of the Product. Controls sold under the WarmlyYours name are warranted for specific coverage periods. Please see <http://www.warmlyyours.com/warranty> for the length of warranty coverage for each control. Should the control be defective or malfunction, return the control to WarmlyYours and it will be repaired or replaced (at WarmlyYours’ discretion). The warranty does not cover removal or reinstallation costs. See entire warranty in packaging.

WarmlyYours Inc. assumes no responsibility under this warranty for any damage to the Product prior to or during installation by anyone, including, but not limited to tradespeople or visitors to the job site, or damage caused as a result of post-installation work. Call our toll free number, (800) 875-5285, if you have any questions about installation. The Limited Warranty is null and void if the Product owner or his representative attempts to repair the Product without receiving authorization. Upon notification of an actual or possible problem, WarmlyYours will issue an Authorization to Proceed under the terms of the Limited Warranty.

Warranty Subject to the Following Conditions: 1. The warranty of the warming system must be registered by completing and returning the attached “System Warranty Registration Card” to WarmlyYours, Inc. within thirty (30) days of date of purchase. Please keep your invoice, as proof of date of purchase will be required in the event of a claim. 2. The heating cable must be installed flat under tile, stone, resilient flooring or laminate wood in a latex-modified thinset or a Portland-based cement. 3. The warming system must be electrically grounded and protected by a GFCI (Ground Fault Circuit Interrupter). 4. The installation must comply with all national and local electrical and building codes, including the National Electrical Code (NEC), the Canadian Electrical Code

(CEC), Part I, and Authority Having Jurisdiction (AHJ), as well as any other applicable statutory requirements. 5. The manufacturer hereby reserves the right to inspect the installation site at any reasonable time. 6. The warranty is not automatically transferred with change of ownership, but the manufacturer may, on application, transfer the warranty for the period remaining. This transfer is solely at the discretion of the manufacturer. 7. The warming system should be used strictly in accordance with the following: 7.1 The voltage of the circuit should match the voltage of the warming system, and the size of the circuit should be such that the warming system does not occupy more than 80% of the circuit capacity. 7.2 Should you feel no warmth on the floor within 60 minutes, verify that there is power to the control or thermostat. Contact WarmlyYours after verifying that there is power through the load wires. Under no circumstances should you or anyone else tamper with or attempt to repair the warming system - this will render the warranty null and void. 7.3 Switch the warming system on and off as you would any conventional electric heater, although timers or thermostats may be used if preferred. 7.4 Use reasonable care in the operation of the warming system. Do not drop heavy articles on the flooring or pierce the flooring with sharp objects. 7.5 All restrictions and warnings detailed in the installation manual must be strictly followed.

WARMLYYOURS, INC. DISCLAIMS ANY WARRANTY NOT PROVIDED HEREIN, INCLUDING ANY IMPLIED WARRANTY OF MERCHANTABILITY OR IMPLIED WARRANTY OF FITNESS FOR A PARTICULAR PURPOSE. WARMLYYOURS FURTHER DISCLAIMS ANY RESPONSIBILITY FOR SPECIAL, INDIRECT, SECONDARY, INCIDENTAL, OR CONSEQUENTIAL DAMAGES ARISING FROM OWNERSHIP OR USE OF THIS PRODUCT, INCLUDING INCONVENIENCE OR LOSS OF USE. THERE ARE NO WARRANTIES WHICH EXTEND BEYOND THE FACE OF THIS DOCUMENT. NO AGENT OR REPRESENTATIVE OF WARMLYYOURS HAS ANY AUTHORITY TO EXTEND OR MODIFY THIS WARRANTY UNLESS SUCH EXTENSION OR MODIFICATION IS MADE IN WRITING BY A CORPORATE OFFICER.

WarmlyYours makes no claim as to the amount of floor/room temperature rise, the time to reach a given floor/room temperature or final floor/room temperature is due to the innumerable variations in building construction and environmental conditions.

RETURN POLICY

Product will be accepted for return if it is in resalable condition. The product must be in exactly the same condition as when we shipped it to you.